

Cell Voltage Monitor

24-channel cell voltage monitor module and sets for H₂ fuel-cell stacks

CVM-24P series





Product Description

A cell voltage monitoring (CVM) system tailored for research, testing and practical application of H₂ fuel cells. The CVM system protects the integrity of individual cells and provides valuable data for predictive maintenance planning and performance optimization.

Adapted for research and testing purposes, the **CVM-24P** system offers excellent accuracy and is designed primarily for electrolyzers.

These ready-to-use cell voltage monitor sets are easily integrated into specialized applications and allow direct connection to a PC via **USB** or to a PLC via **RS-485** or **CAN** bus.

Explore our precision 2.5 V solutions with the **CVM-64H** module and sets, or opt for the cost-effective **CVM-32A** module and sets. For broader temperature and voltage monitoring requirements, consider our **TEVOMET** solutions.

Contact our sales team at sales@kolibrík.net for customized CVMs to meet your specific requirement.

Technical Parameters

| | |
|-----------------------|---|
| Channel count | 24 channels per one CVM-64P module |
| Channel voltage range | ± 5 V |
| Input impedance | ≥ 1 MΩ |
| Isolation | 1 kV between channels and power supply + communication bus Additional isolation can be provided by isolating bus segments |
| Sampling | Precise 24-bit ADCs, all-channel sample rate up to 250 sps |
| Accuracy | 0.02% of range + 0.05% of reading |
| Cell connection | 26-pin IDC connector (automotive-grade connectors on request) |
| Communication bus | RS-485: XC2 / Modbus RTU CAN bus Compatible with other Kolibrík modules |
| Inputs / outputs | Opto-isolated I/O with serial communication capability |
| Power supply | 7 ... 33 V DC / 2.2 W max |
| Application examples | H ₂ fuel-cell tests stands H ₂ fuel-cell application monitoring Electrolyzers monitoring Control systems |



| | | |
|---|--|---|
| <p>Dimensions</p> | <p>CVM-24P module without enclosure CVM-S24P ... CVM-S480P CVM-E24P</p> | <p>85 x 58 x 13.5 mm 90 x 61 x (n^{*)} x 16 + 24) mm 90 x 61 x 16 mm <small>*) n - number of 24-channel modules</small></p> |
| <p>Mounting</p> | <p>DIN-rail and wall-mount holders for set enclosures Single module without enclosure: 4x mounting hole 2.7 mm, hex spacers with M2.5 thread</p> | |
| <p>Channel count examples</p> | <p>Single CVM-24P module CVM-S24P CVM-S48P CVM-S120P CVM-E24P</p> | <p>24 channels 24 channels 48 channels 120 channels additional 24 channels</p> |
| <p>Multiple modules can be daisy-chained to measure up to 480 channels, custom sets for more channels available</p> | | |
| <p>Ambient operating temperature</p> | <p>-40 °C to +85 °C +85 °C to +125 °C module can be powered, measurement inactive</p> | |

*) Channels are organized by groups of 4 channels. Channels in one group can measure up to ±20 V if the sum of group channels does not exceed 20 V. So, one channel can measure up to ±20 V, if other channels in group are short-circuited. Note that adjacent channels and groups are chained together and are not independent.

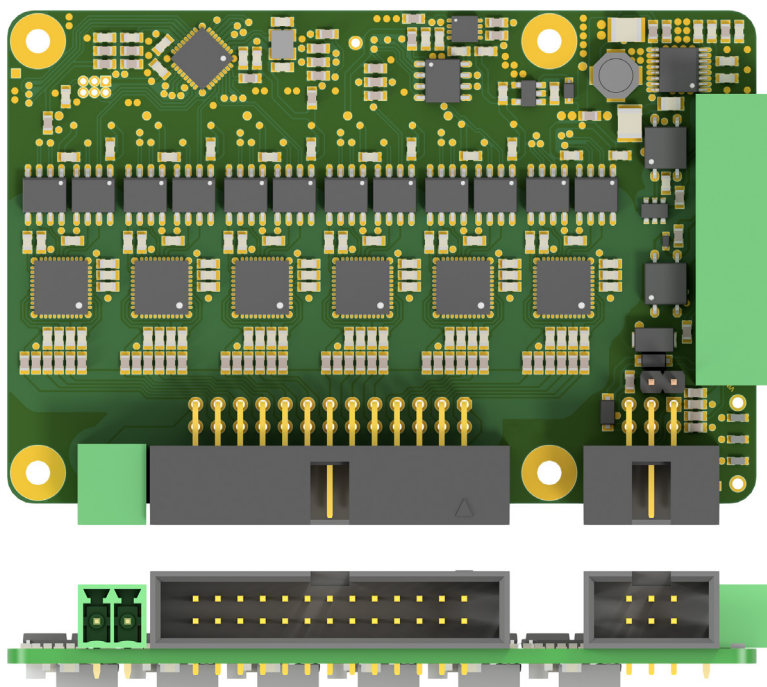

CVM-24P module



System Modularity

Cell voltage monitoring system set

- One power and communication module KMS-PWR
- Number of 24-channel modules CVM-24P, depending on number of channels needed
- Up to 480 channels with step of 48

For high amount of modules, power supply distribution and isolation voltage must be considered. Maximum recommended length for those sets is 20 modules. For more channels, more sets can be chained.

Contact our sales team at sales@kolibrík.net for customized solutions.

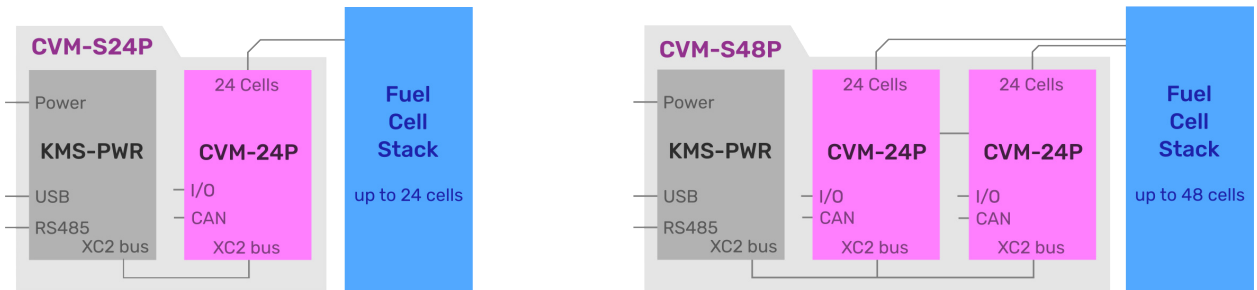

Block scheme of modules in 24-channel **CVM-S24P**

Block scheme of modules in 48-channel **CVM-S48P**

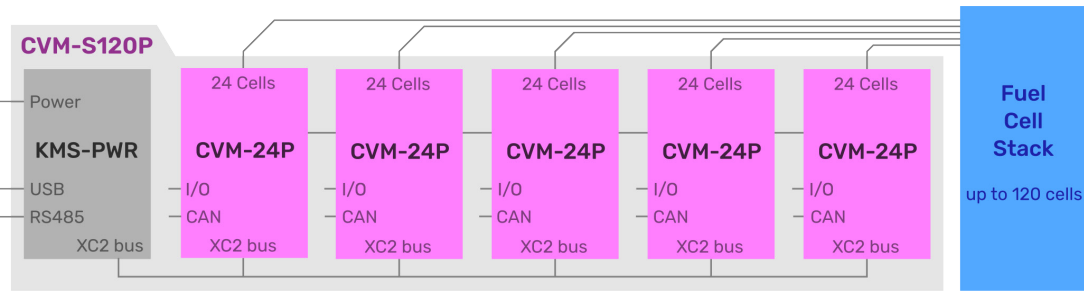

Block scheme of modules in 120-channel **CVM-S120P**

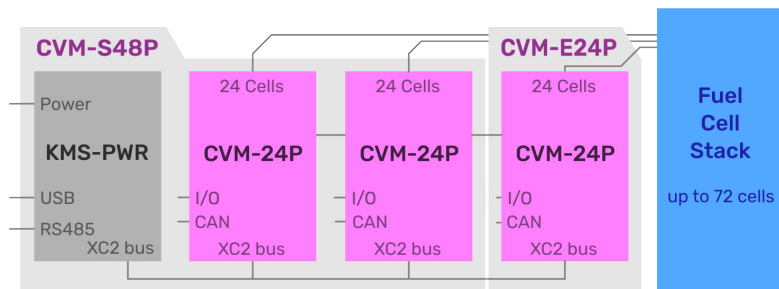

Example of 72-channel monitoring system made by extending **CVM-S48P** by an extension **CVM-E24P**



Cell Connection

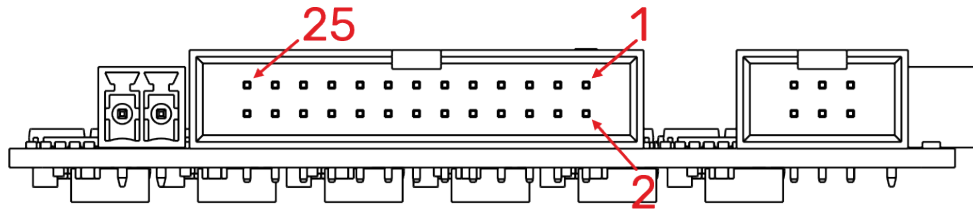

Pinout description of **CVM-24P** channel

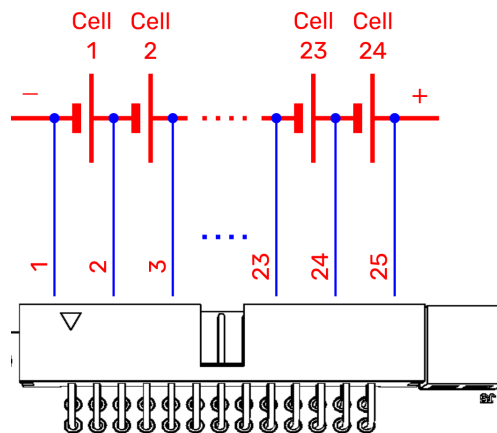

CVM-24P connection of 24 cells

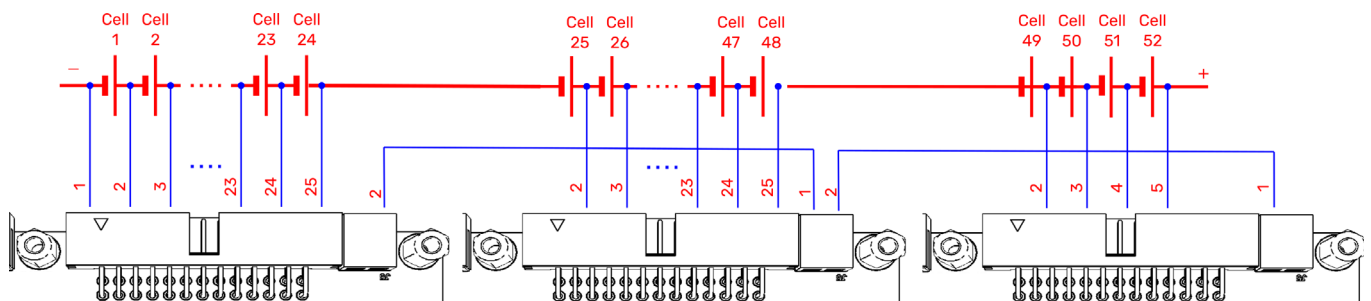

Example of 52-channel connection with chaining
3 CVM-24P modules (2x24 + 1x4 cells)



Integration Options

This section outlines various methods for integrating and utilizing the functionalities of KolibriK.net CVM system. Each method is supported by relevant visual aids to enhance understanding and ease of application.

- Integration via CVM Manager**

Automated Application CVM Manager facilitates real-time monitoring and configuration through its sophisticated interface, which allows users to log data seamlessly and visualize it through dynamic charts.

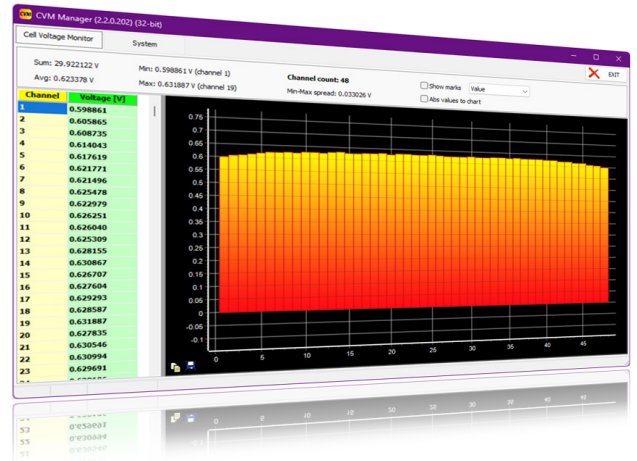

- REST API Server Access via CVM Manager**

CVM Manager also supports a REST API server, readily accessible within the local network. This server allows the execution of standardized HTTP requests, simplifying the process of data retrieval and control.

- Modbus RTU Communication**

The CVM32A device can be configured to operate in Modbus RTU mode, serving as a client within the Modbus network. This facilitates robust and reliable data exchange over this industry-standard protocol.

- Integration with LabView**

Data acquisition and instrument control can be achieved through LabView, using either a direct TCP connection from CvmManager or through serial communication, offering flexible integration options.

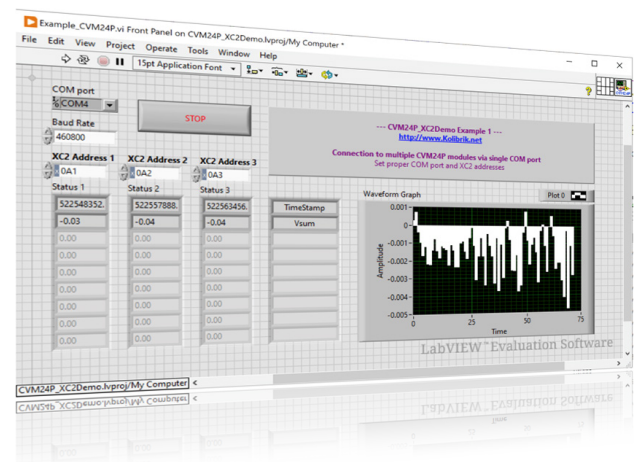



- **Python Library for Custom Scripting**

A dedicated Python library is available, providing developers with the tools to create custom scripts for data handling and device interaction. This library enhances the programmability and versatility of the integration.

```
13 async def main():
14     # Communication settings
15     baud_rate = 1000000
16     cvm32a_address = 0xA1
17
18     # Establish connection with COM port
19     my_ports = discover_serial_ports()
20     bus_sn = get_serial_from_port(my_ports[0])
21     my_bus = SerialBus(bus_sn, port=my_ports[0], baud_rate=baud_rate, protocol_type=ProtocolEnum.XC2)
22     await my_bus.connect()
23
24     # Creating an instance of CVM24P device
25     my_device = XC2Cvm24p(my_bus, cvm32a_address)
26
27     # Reading structure of the registry
28     await my_device.initial_structure_reading()
29
30     await my_device.read_reg_by_name('ch_avg_V')
31     print(f"Register ch_avg_V: {my_device.get_reg_by_name('ch_avg_V')}") # averaged channels values!
32
33
34 if __name__ == "__main__":
35     asyncio.run(main())
36
37 #!python3 main.py
38
39 #!python3 main.py
40
41 #!python3 main.py
42
43 #!python3 main.py
44
45 #!python3 main.py
46
47 #!python3 main.py
48
49 #!python3 main.py
50
51 #!python3 main.py
52
53 #!python3 main.py
54
55 #!python3 main.py
56
57 #!python3 main.py
58
59 #!python3 main.py
60
61 #!python3 main.py
62
63 #!python3 main.py
64
65 #!python3 main.py
66
67 #!python3 main.py
68
69 #!python3 main.py
70
71 #!python3 main.py
72
73 #!python3 main.py
74
75 #!python3 main.py
76
77 #!python3 main.py
78
79 #!python3 main.py
80
81 #!python3 main.py
82
83 #!python3 main.py
84
85 #!python3 main.py
86
87 #!python3 main.py
88
89 #!python3 main.py
90
91 #!python3 main.py
92
93 #!python3 main.py
94
95 #!python3 main.py
96
97 #!python3 main.py
98
99 #!python3 main.py
100
```

- **Modbus TCP via External Gateway**

For environments requiring Modbus TCP communication, an external gateway such as the RPi kit can be utilized. This setup allows the system to connect with TCP networks, expanding its compatibility and application scope.

- **Smart integration with Raspberry Pi**

With the flexibility of Raspberry Pi, you can develop and implement custom scripts and applications that tailor the monitoring system to your specific needs. You can access, collect and process real-time data and make adjustments remotely.







Kolibrík integration example - **CVM-S48P** with **Raspberry Pi**

These integration methods ensure that users can customize their experience to meet specific requirements and preferences, leveraging the full capabilities of our technology in a variety of operational contexts.



Ordering Information examples

| | | |
|------------------|--|---|
| <p>CVM-S24P</p> | <p>Power source KMS-PWR; 1x CVM-24P 24 channels total Out of Box Solution</p> |  |
| <p>CVM-S48P</p> | <p>Power source KMS-PWR; 2x CVM-24P 48 channels total Out of Box Solution</p> |  |
| <p>CVM-S120P</p> | <p>Power source KMS-PWR; 5x CVM-24P 120 channels total Out of Box Solution</p> |  |
| <p>CVM-E24P</p> | <p>Extension for assembly set; 1x CVM-24P 24 additional channels Extension for set</p> |  |

CVM Set Package Contains

- 1x KMS-PWR; n^{*)} x CVM-24P; 1x DC Power connector; 1x USB cable;
- 1x XC2 bus cable; n^{*)} x clamps for I/O, CAN and chaining; DIN rail holders

*) n - number of 24-channel modules

Disclaimer

All rights reserved. All data contained within this manual is for information purposes only and is not guaranteed for legal purposes. The Information has been checked carefully and is believed to be accurate; however, no responsibility is assumed for any inaccuracies. Kolibrík.net, s.r.o. reserves the right to change, modify, or improve this document or the product described herein, as seen fit without further notice.

Proprietary Note

This document contains proprietary information and is the property of Kolibrík.net, s.r.o. or under license from third parties. No part of this document may be reproduced, copied, or transmitted in any form or by any means, disclosed to others, or stored in any retrieval system or media without the prior written consent of Kolibrík.net, s.r.o.