

EX PRESSURE TRANSMITTER

Swiss based Trafag is a leading international supplier of high quality sensors and monitoring instruments for measurement of pressure and temperature. The EX pressure transmitter EXNT is based on Trafag's own thin-film-on-steel sensor technology with excellent long-term stability and offers reliable and accurate pressure measurement over a wide temperature range. The intrinsic safety design is certified for applications in Ex-Zones 0, 1, 2 (gas), 20, 21, 22 (dust) and mining.



Applications

- Shipbuilding
- Ex Zones 0, 1, 2 (gas); 20, 21, 22 (dust) and mining
- Hydrogen

Features

- II 1G Ex ia IIC T4/T6 Ga
- II 1D Ex ia IIIC T₂₀₀ 160°C Da
- I M1 Ex ia I Ma
- II 1/2G Ex ia IIC T4/T6 Ga/Gb (with plastic-type connector)
- Pressure ranges from 0.4 to 2000 bar
- Completely welded sensor system
- Optional with hydrogen-compatible sensor
- ATEX and IECEx

Technical Data

Measuring principle	Thin-film-on-steel	Accuracy @ 25°C typ.	± 0.5 % FS typ. ± 0.3 % FS typ.
Measuring range	0 ... 0.4 to 0 ... 2000 bar 0 ... 5 to 0 ... 30000 psi	Media temperature	Max. -40°C ... +120°C (see electrical connection)
Output signal	4 ... 20 mA	Ambient temperature	Max. -40°C ... +120°C (see electrical connection)
NLH @ 25°C (BSL) typ.	± 0.2 % FS typ. ± 0.1 % FS typ.	Approval / conformity	DNV-GL, KRS, RMRS ATEX / IECEx, according to the norm EN/IEC 60079-0/EN 60079-11/ EN 60079-26/ EN 50303

02/2022

Data sheet H7329x

Subject to change

Ordering information/type code

				8292 . XX				XX	XX	XX	XX	XX
Measuring range ¹⁾	Pressure measurement range [bar]	Over pressure [bar]	Burst pressure [bar]	Pressure measurement range [psi]	Over pressure [psi]	Burst pressure [psi]						
		0 ... 0.4 ²⁾	1.2	25	0 ... 5 ²⁾	18	350	F9				
	0 ... 0.6 ²⁾	1.5	25	0 ... 10 ²⁾	25	350	G0					
	0 ... 1.0 ²⁾	2.0	25	0 ... 15 ²⁾	30	350	G1					
	0 ... 1.6	3.5	80	0 ... 25	50	1200	G3					
	0 ... 2.5	5	100	0 ... 30	30	720	G5					
	0 ... 4	8	100	0 ... 50	120	860	G6					
	0 ... 6	12	100	0 ... 100	170	1450	G7					
	0 ... 10	20	200	0 ... 150	290	2900	G8					
	0 ... 16	32	200	0 ... 250	460	2900	G9					
	0 ... 25	50	300	0 ... 400	730	4350	H0					
	0 ... 40	80	300	0 ... 500	1160	4350	H1					
	0 ... 60	120	500	0 ... 1000	1740	5800	H2					
	0 ... 100	200	500	0 ... 1500	2900	7250	H3					
	0 ... 160	320	1000	0 ... 2000	4640	10850	H5					
	0 ... 250	500	1000	0 ... 3000	7250	14500	G4					
	0 ... 400	800	1500	0 ... 5000	11600	21750	H4					
	0 ... 600	1000	2000	0 ... 7500	14500	29000	H6					
	0 ... 1000 ⁹⁾	1600	3000	0 ... 15000 ⁹⁾	25000	45000	H8					
	0 ... 1600	3000	4000	0 ... 25000	45000	60000	H9					
	0 ... 2000	3000	4000	0 ... 30000	45000	60000	J0					
Sensor	Relative pressure, accuracy: 0.3% (> 1 bar)						23					
	Relative pressure, accuracy: 0.5% (> 1 bar)						25					
	Relative pressure, accuracy: 0.5% (≤ 1 bar)						26					
	Relative pressure, accuracy: 0.5 %, wetted parts hydrogen compatible ^{7) 8)}						35					
	Relative pressure, accuracy: 0.3 %, wetted parts hydrogen compatible ^{7) 8)}						33					
Pressure connection	G1/4" male ³⁾						17					
	G1/4" male (Manometer) EN 837 ^{3) 8)}						53					
	G1/4" female ^{3) 8)}						10					
	G1/2" male ^{3) 8)}						21					
	G1/2" male (Manometer) EN 837 ^{3) 8)}						11					
	R1/4" male ^{3) 8)}						19					
	1/4" NPT male ^{3) 8)}						30					
	M18x1.5 male (conical seal: 58°) ^{4) 8)}						29					
Electrical connection	Male electrical connector EN 175301-803-A, plastic						05					
	Male electrical connector M12x1, 5-pole, metal						35					
	Male electrical connector MIL-C 26482, 6-pole, metal ⁵⁾						02					
	Male electrical connector Binder 723, 5-pole, metal						14					
	Cable with shield, material FDR 25 (Raychem), 4 x 0.5mm ² (cable length see "Accessories") - not ship approved ¹⁰⁾						78					
	Cable intrinsically safe with shield, material PVC, 2 x 0.75mm ² (-40...+80°C), (cable length see "Accessories") - not ship approved ¹⁰⁾						80					
Output signal	Signal output	Load resistance	I (supply)	U (supply)								
	4 ... 20 mA	(Usupply-10 V) / 20 mA		10 ... 30 VDC							19	

Accessories	Female electrical plug EN 175301-803-A (DIN43650-A)/NBR, -40°C ... +90°C, for cable diameter 4 ... 9 mm, flammability standard UL94-V0	46
	Female electrical plug EN 175301-803-A (DIN43650-A)/silicone, -40°C ... +125°C, for cable diameter 4 ... 9 mm, flammability standard UL94-V0	56
	Female electrical plug EN 175301-803-A (DIN43650-A)/NBR, -40°C ... +90°C, for cable diameter 4 ... 9.5 mm, flammability standard UL94-V2 ¹¹⁾	58
	Female electrical plug M12x1, 5-pole, plastic (not for zones 0 (gas))	33
	Female electrical plug M12x1, 5-pole, metal	35
	Female electrical plug MIL-C 26482, 6-pole, metal	32
	Female electrical plug Binder 723, 5-pole, metal	37
	Pressure peak damping element ø 0.4 mm	44
	Pressure peak damping element ø 1.0 mm	40
	Cable length 1.5 m ⁶⁾	1M
	Cable length 3.0 m ⁶⁾	3M
	Cable length 5.0 m ⁶⁾	5M
	Special electrical connection: Pin 1 +, Pin 2 - (only for output signal 4 ... 20 mA and male electrical connector EN175301-803-A / DIN43650-A)	92
	Zener barrier ATEX/IECEX 28V/93mA; R ≈300Ω; Ordering no ZEN28VDC	
	Damping elements and snubber see data sheet H72258	

¹⁾ Extended overpressure as well as customized pressure ranges upon request

²⁾ Only with sensor 26 (0.5%)

³⁾ For pressure ranges ≤ 600 bar

⁴⁾ For pressure ranges > 600 bar

⁵⁾ For pressure ranges < 40 bar upon request

⁶⁾ Other cable lengths upon request

⁷⁾ Pressure ranges 0 ... 40 to 0 ... 1000 bar, max. ambient and media temperature +85°C

⁸⁾ Upon request

⁹⁾ With sensors 33 and 35: Overpressure 1300 bar/19000 psi, Burst pressure 2600 bar/38000 psi

¹⁰⁾ Cable length max. 20 m

¹¹⁾ Without ship approval DNV-GL

Standard products (extra short lead time)

Product No.	Type Code	Pressure range [bar]	Over pressure max. [bar]	Supply [VDC]	Accuracy @ 25°C typ. [%]
EXNT0.4A	8292 69 2617 05 0000 0000 19 46 92	0 ... 0.4	1.2	10 ... 30	± 0.5
EXNT0.6A	8292 70 2617 05 0000 0000 19 46 92	0 ... 0.6	1.5	10 ... 30	± 0.5
EXNT1.0A	8292 71 2617 05 0000 0000 19 46 92	0 ... 1	2	10 ... 30	± 0.5
EXNT2.5A	8292 75 2517 05 0000 0000 19 46 92	0 ... 2.5	5	10 ... 30	± 0.5
EXNT4.0A	8292 76 2517 05 0000 0000 19 46 92	0 ... 4	8	10 ... 30	± 0.5
EXNT6.0A	8292 77 2517 05 0000 0000 19 46 92	0 ... 6	12	10 ... 30	± 0.5
EXNT10.0A	8292 78 2517 05 0000 0000 19 46 92	0 ... 10	20	10 ... 30	± 0.5
EXNT16.0A	8292 79 2517 05 0000 0000 19 46 92	0 ... 16	32	10 ... 30	± 0.5
EXNT25.0A	8292 80 2517 05 0000 0000 19 46 92	0 ... 25	50	10 ... 30	± 0.5
EXNT40.0A	8292 81 2517 05 0000 0000 19 46 92	0 ... 40	80	10 ... 30	± 0.5
EXNT100.0A	8292 83 2517 05 0000 0000 19 46 92	0 ... 100	200	10 ... 30	± 0.5
EXNT250.0A	8292 74 2517 05 0000 0000 19 46 92	0 ... 250	500	10 ... 30	± 0.5

Additional information

Documents	Data sheet	www.trafag.com/H72329
	Instructions	www.trafag.com/H73329
	Flyer	www.trafag.com/H70657

Specifications		
Electrical Data	Output / supply voltage	4 ... 20 mA; 24 (10 ... 30) VDC
	Rise time	Typ. 1 ms / 10 ... 90 % nominal pressure
	Power-on delay time	Max. 1.5 s
Environmental conditions	Media temperature	Max. -40°C ... +120°C (see electrical connection)
	Ambient temperature	Max. -40°C ... +120°C (see electrical connection)
	Protection ¹⁾	Min. IP65 Electrical connection cable: IP67 Electrical connection 02: IP67
	Humidity	Max. 95 % relative
	Vibration	10 g (50...2000 Hz)
	Shock	50 g / 3 ms
EMC Protection	Emission	IEC 61000-6-4
	Immunity	IEC 61000-6-2
Mechanical Data	Sensor (wetted parts)	1.4542 (AISI630), optional hydrogen-compatible steel
	Pressure connection (wetted parts)	Pressure ranges ≤ 250 bar and > 600 bar: 1.4542 (AISI630) Pressure ranges > 250 bar and ≤ 600 bar: 1.4301 (AISI304) Optional hydrogen-compatible steel
	Housing	1.4301 (AISI304)
	Sealing	FKM 70 Sh
	Male electrical connector	See ordering information
	Weight	~ 165 g
	Mounting torque	25 Nm Pressure connection 29: 30 Nm

¹⁾ See electrical connection

Accuracy				
		Class 0.5 % Ordering No. 25/35 (> 1 bar)	Class 0.3 % Ordering No. 23/33 (> 1 bar)	Class 0.5 % Ordering No. 26 (≤ 1 bar)
TEB @ -25 ... +85°C	[% FS typ.]	± 2.0	± 0.5	± 1.0
Accuracy @ +25°C	[% FS typ.]	± 0.5	± 0.3	± 0.5
NLH @ +25°C (BSL)	[% FS typ.]	± 0.2	± 0.1	± 0.1
TC zero point and span	[% FS/K typ.]	± 0.03	± 0.005	± 0.01
Long term stability 1 year @ +25°C	[% FS typ.]	± 0.2	± 0.2	± 0.2
Mounting dependency with 180° rotation (Vibration and shock: multiply this value with number of g)	[% FS typ.]	-	-	0 ... 1 bar: 0.05 0 ... 0.6 bar: 0.09 0 ... 0.4 bar: 0.13

Class 0.5 %

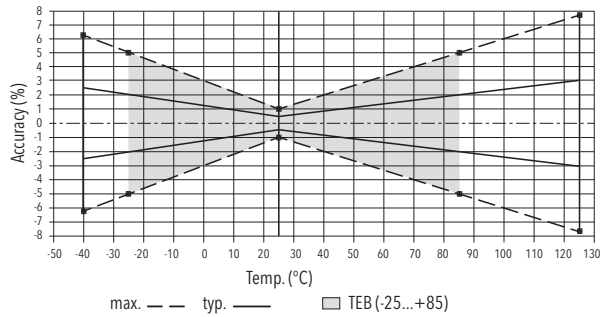

Class 0.3 %

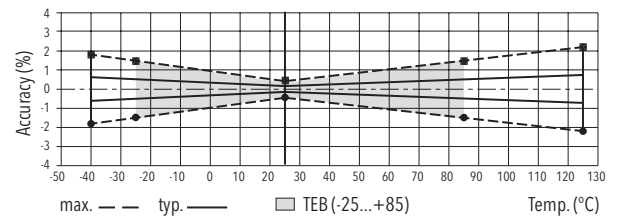

Electrical connection

		Protection / electrical connection						
		IP65*)	IP67	IP67	IP65*)	IP67*)	IP65*)	
		Industrial standard EN175301-803A	Cable **) (4 x 0.5 mm ²)	Cable **) (2 x 0.75 mm ²)	Binder 723	MIL-C 26482	M12x1 5-pole	
		05	78 Shield	80 Shield	14	02	35	
Output signal		Standard 2 1 ⊕	92 1 2 ⊕	brown black yellow / green (blue = not connected)	1 (black) 2 (black) -	3 1 5	A C F	4 1 5
	8292 .XX.XXXX.XX.19							
T-Range	Ambient and media temperature T4	-40 ... +120°C ¹⁾	-40 ... +120°C ¹⁾	-40 ... +80°C	-30 ... +95°C ¹⁾	-40 ... +120°C ¹⁾	-40 ... +120°C ¹⁾	
	Ambient and media temperature T6	-40 ... +65°C	-40 ... +65°C	-40 ... +65°C	-30 ... +65°C	-40 ... +65°C	-40 ... +65°C	
	For Ex zones	1, 2 20, 21, 22		0, 1, 2 20, 21, 22		0, 1, 2 20, 21, 22		

* **Attention!** Additional measure against static charges are required for Zone 0 to 20 for these cables (laid with earthed metal braid, metal hose or metal pipe).

*) Provided female connector is mounted according to instructions

**) Ventilation via cable end

***) Only cable versions or female electrical plug with shield connection

¹⁾ With sensors 33 and 35: max. +85°C

Marking	
For Ex zones	Marking
0, 1, 2, 20, 21, 22 M1, M2	 II 1G Ex ia IIC T4/T6 Ga II 1D Ex ia IIIC T ₂₀₀ 160°C Da I M1 Ex ia I Ma
1, 2 20, 21, 22 M2	 II 2 G Ex ia IIC T4/T6 Gb (version with plastic type connector) II 1D Ex ia IIIC T ₂₀₀ 160°C Da I M1 Ex ia I Ma

Dimensions

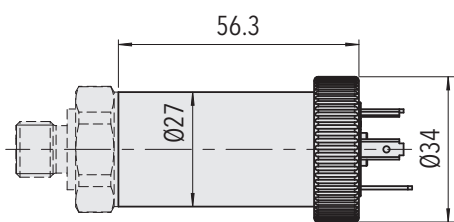

8292.XX.XXXX.05.XX.XX

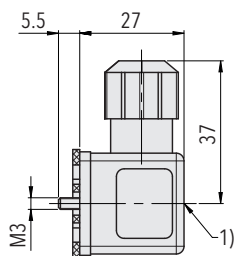

1) Tightening torque 50...60 Ncm

8292.XX.XXXX.XX.XX.46/56

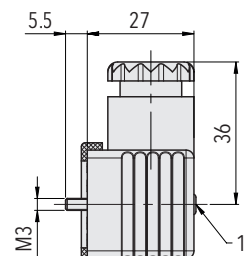

1) Tightening torque 50...60 Ncm

8292.XX.XXXX.XX.XX.58

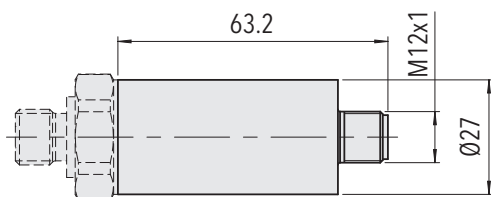

8292.XX.XXXX.35.XX.XX

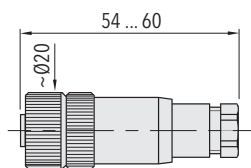

8292.XX.XXXX.XX.XX.33/35

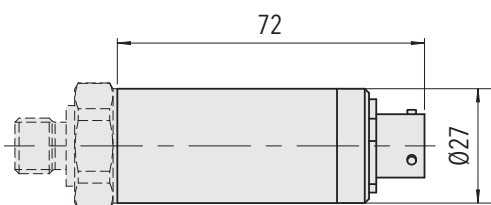

8292.XX.XXXX.02.XX.XX

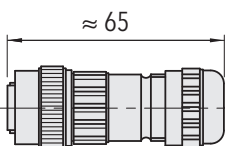

8292.XX.XXXX.XX.XX.32

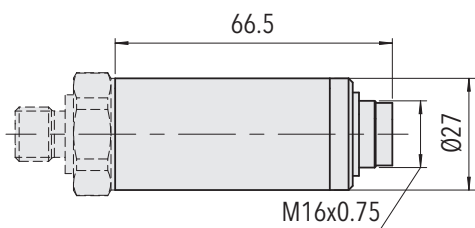

8292.XX.XXXX.14.XX.XX

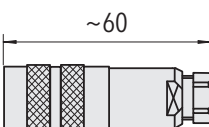

8292.XX.XXXX.XX.XX.37

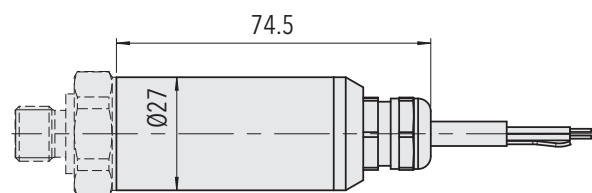

8292.XX.XXXX.78/80.XX.XX

Dimensions

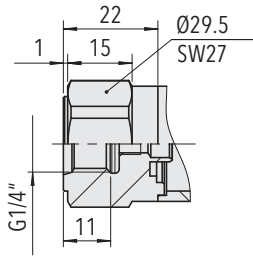

8292.XX.XX10.XX.XX.XX
(≤ 600 bar)

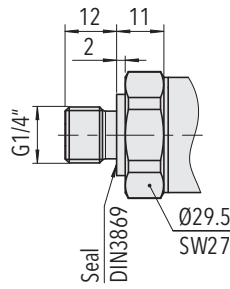

8292.XX.XX17.XX.XX.XX
(≤ 600 bar)

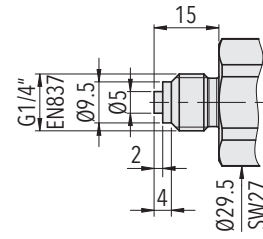

8292.XX.XX53.XX.XX.XX

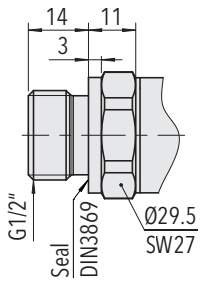

8292.XX.XX21.XX.XX.XX
(≤ 600 bar)

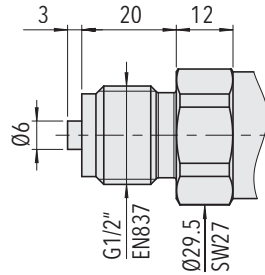

8292.XX.XX11.XX.XX.XX
(≤ 600 bar)

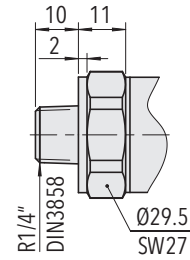

8292.XX.XX19.XX.XX.XX
(≤ 600 bar)

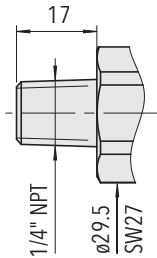

8292.XX.XX30.XX.XX.XX
(≤ 1000 bar)

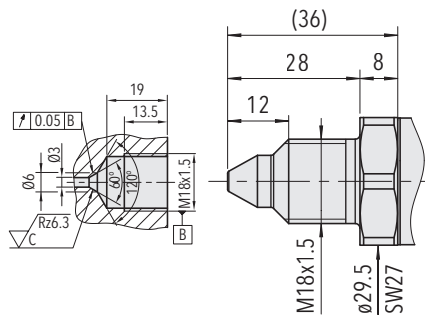

8292.XX.XX29.XX.XX.XX
(> 600 bar)